

The GV60 MAX Electronic Ignition Remote Control system is used on the Valor heaters models 700, 780 and 785

Remote Control Initial Set-up

The receiver and the handset of the remote control system must be initially synchronized before the first use.

1. Insert alkaline batteries in the remote control receiver and handset. The receiver is located left of the control valve under the burner module.
2. With a sharp object, press and hold the receiver's reset button until you hear one short and one long beeps. Release the reset button after the second beep.
3. Within the subsequent 20 seconds, press the small flame button () on the remote handset until you hear two short beeps confirming the synchronization is set.

This is a one time setting only and is not required when changing the batteries in the remote receiver. The remote control system is now ready to use.

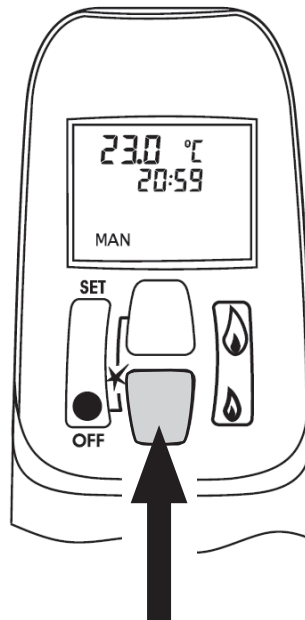
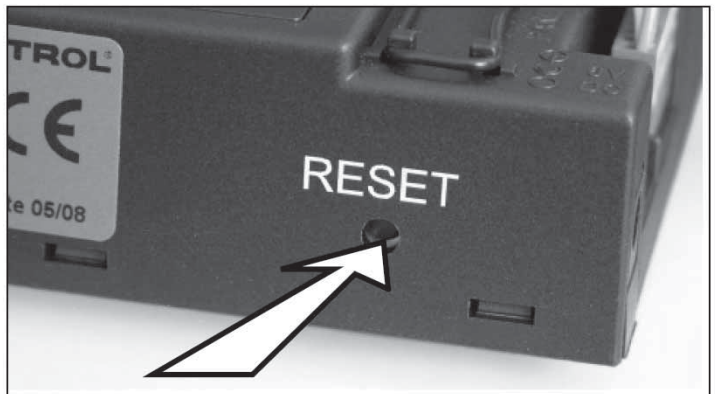

Remote Control Operation

NOTE: Before using the remote control system for the first time, the receiver and the handset must be synchronized. See the section *Remote Control Initial Set-up* on the previous page of this manual.

IMPORTANT: BEFORE YOU BEGIN, please note that on this system, the settings of time, temperature and automatic ON/OFF can only be programmed when the function display is flashing. Be patient when programming as it can take a few seconds to set.

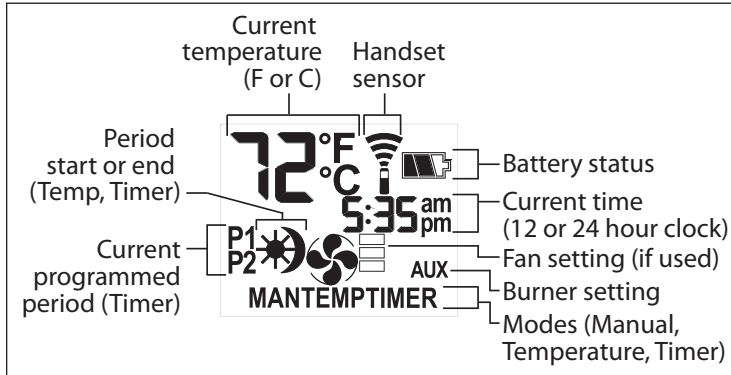

Display Overview

Note: In the TEMP or TIMER modes, the remote handset senses the room temperature and adjusts the flame accordingly.

To communicate, the handset should be within 15 feet (4.5 meters) of the fireplace.

Do not leave the handset on the mantel or hearth.

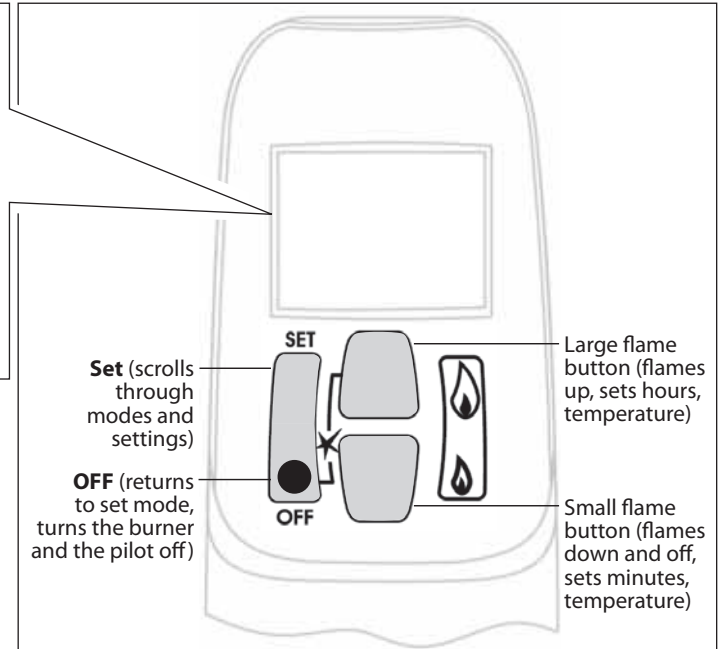

Handset Overview

TO TURN ON APPLIANCE

WARNING

When pilot ignition is confirmed, motor turns automatically to maximum flame height.

- On the valve, turn MAN knob on the ON, full counterclockwise ↺ position.
- Place ON/OFF switch (if equipped) in I (ON position).

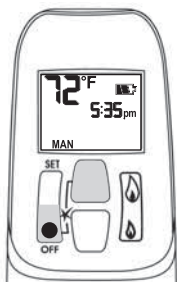

- Simultaneously press the OFF and 🔥 (large flame) buttons until a short beep confirms the start sequence has begun; release buttons.
- Continuing beeps confirm the ignition is in process.
- Once pilot ignition is confirmed, there is main gas flow.
- After main burner ignition the handset will automatically go into manual (MAN) control mode.

TO TURN OFF APPLIANCE

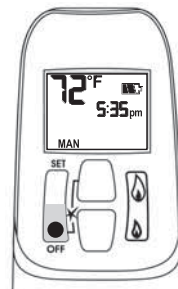

- Press OFF button.

When the pilot is off, it will take 2 minutes before it can be lit again.

STANDBY MODE (Pilot Flame)

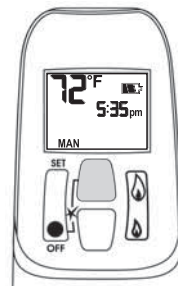

- Press and hold 🔥 (small flame) to set appliance at pilot flame.

FLAME HEIGHT ADJUSTMENT



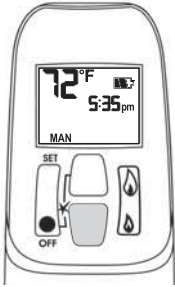

- In standby mode: Press and hold 🔥 (large flame) button to increase flame height.



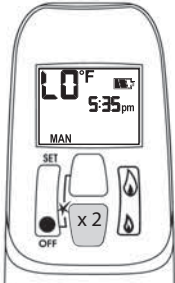

- Press and hold  (small flame) button to decrease flame height or to set the appliance at pilot flame.
- For fine adjustment tap the  (large flame) or  (small flame) buttons.

Express Low and High Fire

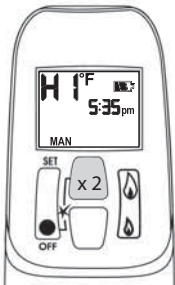

- Double-click  (small flame) button. "LO" will be displayed. NOTE: Flame goes to high fire first before going to designated low fire.



- Double-click  (large flame) button. Flame automatically goes to high fire. "HI" will be displayed.





SETTING °C/24-HOUR OR °F/12-HOUR CLOCK

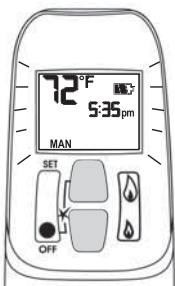

- In MAN mode, press OFF and  (small flame) buttons until display changes from Fahrenheit/12-hour clock to Celsius/24-hour clock and vice versa.

SETTING THE TIME



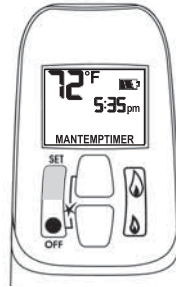

- The time display will flash after either:
 - Installing the battery or
 - Simultaneously pressing the  (large flame) and  (small flame) buttons.
- Press  (large flame) button to set the hour.
- Press  (small flame) button to set the minute.
- Press OFF or simply wait to return to MAN mode.

MODES OF OPERATION

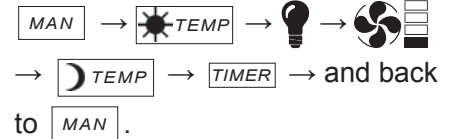

- Briefly pressing the SET button changes the mode of operation in the following order:



NOTE: Manual mode can also be reached by pressing either the  (large flame) or the  (small flame) buttons.

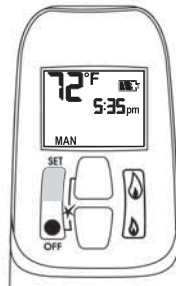

-  - **Manual Mode** - Manual Flame Height Adjustment.

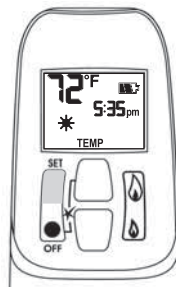



-  - **Daytime Temperature Mode** (Appliance must be in standby mode; pilot ignited) - The room temperature is measured and compared to the set temperature. The flame height is then automatically adjusted to achieve the Daytime Set Temperature.



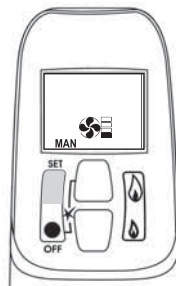

-  - **Light/Dimmer Setting Mode**
Not available on this fireplace.



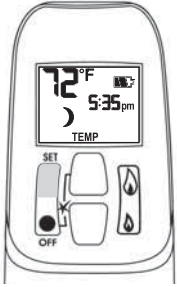

-  - **Fan Mode** - Turns fan ON and OFF and adjusts fan speed.

NOTE: To turn OFF fan press  (small flame) until all 4 speed level bars disappear.

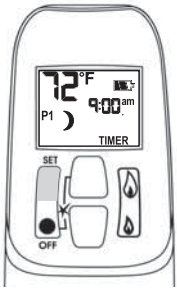

-  - **Nighttime Setback Temperature Mode** (Appliance must be in standby mode; pilot ignited) - The room temperature is measured and compared to the Nighttime Setback temperature. The flame height is then automatically adjusted to achieve the Nighttime Setback Temperature.



-  - **Timer Mode** (Appliance must be in standby mode; pilot ignited) - The timers P1 and P2 (Program 1, Program 2) each can be programmed to go ON and OFF at specific times. For instructions see Timer Programming Mode.





NOTE: The display shows the set temperature every 30 seconds.

CIRCULATING FAN OPERATION (if equipped)



Circulating Fan - The circulating fan has 4 speed levels from low (1 bar) to high (4 bars).



- Briefly press SET button to scroll to  (fan) mode. Fan and Level icons flash.
- Press  (large flame) button to switch ON and increase fan speed.
- Press  (small flame) button to decrease fan speed. To turn OFF fan, press  (small flame) button until all 4 speed level bars disappear.

NOTE: 8 seconds after the fan has been set, the handset will automatically go into temperature control mode. The fan starts 4 minutes after the gas opens (from OFF or from pilot) at maximum speed and goes to the displayed level after 10 seconds. The fan stops 10 minutes after the gas is OFF or at pilot.

TO OPEN AND CLOSE DOUBLE BURNER (785 fireplace models only)

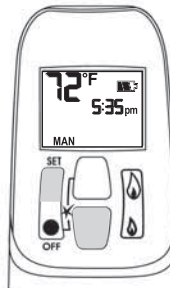

NOTE: The rear part of the double burner cannot be activated manually: it can only function with the remote control. However, if the battery runs down, the rear part of the burner will run according its the last operating position. During normal operation when lit with the remote control, both parts of the burner turn on regardless of the setting during the last use of the fireplace.

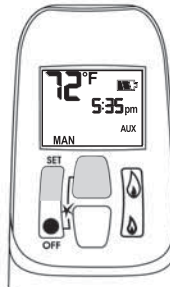

Rear burner
OFF



Rear burner
ON

- Upon ignition both parts of the burner are ON.
- Simultaneously press SET and  (small flame) buttons to switch the rear burner OFF. Printed instructions are on the handset's battery cover.
- Simultaneously press SET and  (large flame) buttons to switch rear part of the burner on. The AUX symbol on the handset display indicates that the rear part of the burner is ON.

NOTE: The function AUX is blocked in programming mode (TIMER, P1 or P2) when the Nighttime Setback Temperature  is set at --.



Double burner ON/
OFF commands
diagram at the rear
of the handset

Tip

Set the different parameters when they are flashing.

SETTING THE ON / OFF TEMPERATURES

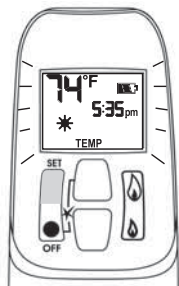

SETTING THE “DAYTIME” TEMPERATURE

Default Settings:  TEMP (sun), 23°C / 74°F



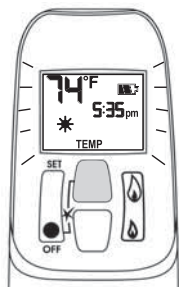

- Briefly press SET button to scroll to TEMP  TEMP (sun) mode. Hold the SET button until the TEMP flashes.

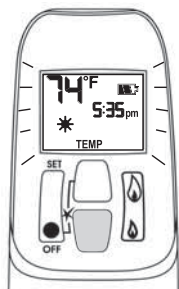

- Press  (large flame) button to increase the  Daytime Set Temperature.



- Press  (small flame) button to decrease  Daytime Set Temperature.

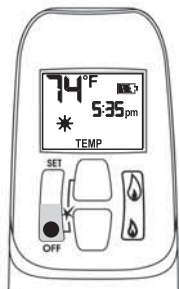

- Press OFF or simply wait to complete programming.

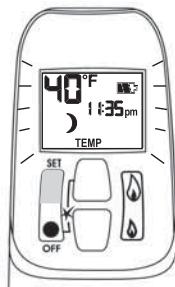

SETTING THE “NIGHTTIME SETBACK” TEMPERATURE

Default Settings:  TEMP (moon), “--” (OFF)



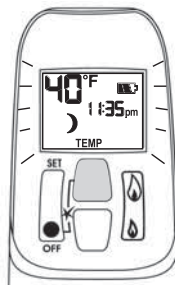

- Briefly press SET button to scroll to TEMP  TEMP (moon) mode. Hold the SET button until the TEMP flashes.

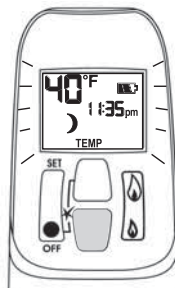

- Press  (large flame) button to increase  Nighttime Setback Temperature.



- Press  (small flame) button to decrease  Nighttime Setback Temperature.

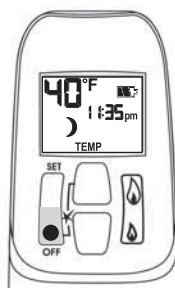

- Press OFF or simply wait to complete programming.

SETTING PROGRAM TIMERS

- You can program two periods of time between 12:00 am and 11:50 pm in each 24-hour cycle.
- The Programs P1 and P2 must be set in the following order during a 24-hour cycle: **P1** ☀, **P1** 🌙, **P2** ☀ and **P2** 🌙
- The icon ☀ indicates the beginning of the period (ON) and the icon 🌙 indicates the end of the period (OFF).
- If **P1** ☀ = **P1** 🌙 or **P2** ☀ = **P2** 🌙, the programming is cancelled.
- To keep the fireplace ON all night, set **P2** 🌙 at 11:50 am and **P1** ☀ at 12:00 am.

Default settings:

Program 1: **P1** ☀ 6:00 am **P1** 🌙 8:00 am

Program 2: **P2** ☀ 11:50 pm **P2** 🌙 11:50 pm

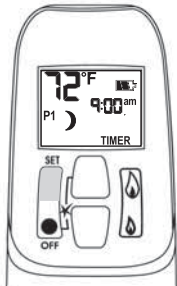

- Briefly press SET button to scroll to TIMER mode.

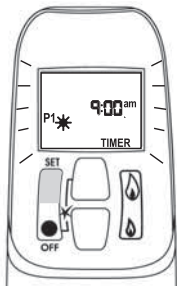

SETTING P1 ON TIME

- Hold the SET button until **P1** ☀ (sun) is displayed and the time flashes.

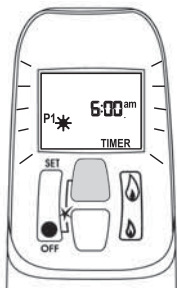

- Press 🔥 (large flame) button to set the hour.

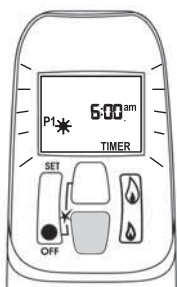

- Press 🔥 (small flame) button to set the minutes.

SETTING P1 OFF TIME

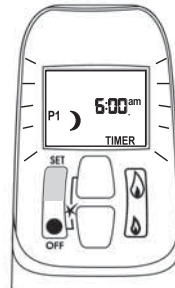

- Briefly press SET button to scroll to TIMER **P1** 🌙 (moon) while the time flashes.

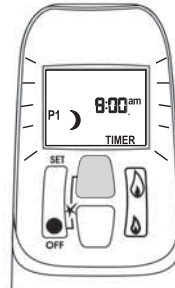

- Press 🔥 (large flame) button to set the hour.

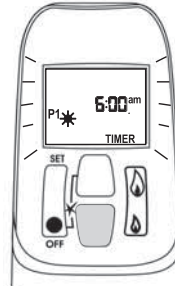

- Press 🔥 (small flame) button to set the minutes.

SETTING P2 ON TIME

- Briefly press SET to scroll to TIMER mode **P2** ☀ (sun) while the time flashes.
- Follow the instructions given to set P1 ON time.

SETTING P2 OFF TIME

- Briefly press SET to scroll to TIMER mode **P2** 🌙 (moon) while the time flashes.
- Follow the instructions given to set P1 OFF time.

Press OFF button to save these settings. The timers are programmed. See the diagram on programming sequences on the following page.

Tip

If you want to program only one period, program **P1** ☀ and **P1** 🌙 with desired times and program **P2** ☀ and **P2** 🌙 with the same time as **P1** 🌙.

Timer Programming Example (default temperatures shown)

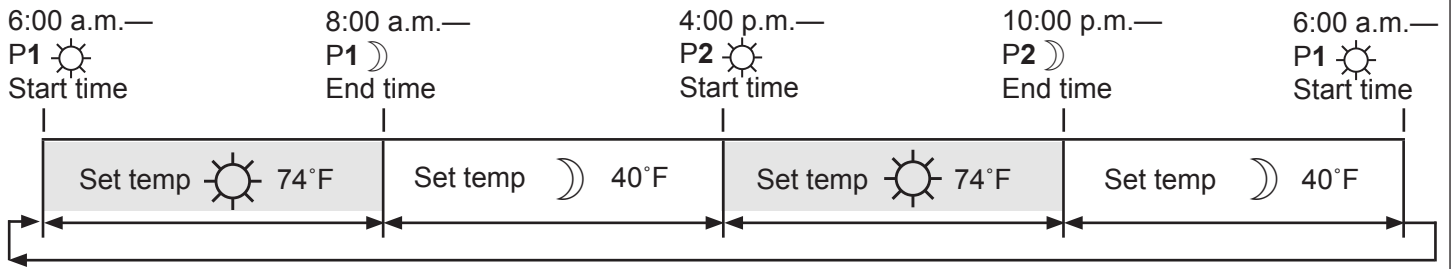

AUTOMATIC TURN DOWN

- **No communication.** If there is no communication between the receiver and the handset for a period of 6 hours, the appliance goes into pilot mode.
- **No change in flame height.** If there is no change in flame height for a period of 6 hours, the appliance goes into pilot mode.
NOTE: In **TEMP** or **TIMER** modes, the flame height will vary according to room temperature. The appliance will continue to work normally. However, if the room temperature remains the same for 6 hours, the appliance will go into pilot mode.

AUTOMATIC SHUT OFF

- **Low batteries in the receiver.** With low battery power in the receiver the system shuts off completely.
NOTE: This does not apply when the power supply is interrupted.
- **No change in pilot.** The appliance shuts off completely when it is continually in pilot position—without any change—for a period of 5 days.

LOW BATTERY INDICATION

CAUTION

DO NOT USE a screwdriver or other metallic object to remove the batteries from the battery box or the handset! This could cause a short circuit.

Remote handset: The battery icon  will show when the battery needs to be replaced. Replace with one 9 V **alkaline** battery.

Receiver: Three short 'beeps' will sound when the motor turns when the batteries need to be replaced. Replace with four 1.5 V **alkaline** batteries.

HANDSET / RECEIVER MATCH

The remote control handset and receiver are programmed to function together. In case of a replacement of the handset or the receiver, you will need to reset the receiver to allow them to function together. Contact your dealer for details.

Because our policy is one of constant development and improvement, details may vary slightly from those given in this publication.

Miles Industries Ltd.

190–2255 Dollarton Highway, North Vancouver, BC, CANADA V7H 3B1

Tel. 604-984-3496 Fax 604-984-0246

www.valorfireplaces.com